



STARK

Housing Aluminium injection with electrostatic powder coating and air valve (ventile), monoblok silikon gasket

Optics Special design, clear, acrylic (PMMA) optic lens

Glass 4mm clear tempered glass

LED High-power LED with high efficacy

Driver Constant current driver with high efficiency

Ambient Temperature
-40 °C/+50 °C

Impact Resistance
Glass : IK08
Body : IK10



ARL-G90 Ral 9005

Type Code	Power (w)	CCT (K)	Light Output (lm)	CRI	V/Hz	Weight (Kg)
BSTA.550.48.40.L1	48	4000	7710	>70	220 - 240 / 50 - 60	8,5
BSTA.550.48.40.L2	48	4000	7750	>70	220 - 240 / 50 - 60	8,5
BSTA.550.48.40.L3	48	4000	7780	>70	220 - 240 / 50 - 60	8,5
BSTA.550.48.40.L4	48	4000	7850	>70	220 - 240 / 50 - 60	8,5
BSTA.550.58.40.L1	58	4000	8980	>70	220 - 240 / 50 - 60	8,5
BSTA.550.58.40.L2	58	4000	9000	>70	220 - 240 / 50 - 60	8,5
BSTA.550.58.40.L3	58	4000	9150	>70	220 - 240 / 50 - 60	8,5
BSTA.550.58.40.L4	58	4000	9180	>70	220 - 240 / 50 - 60	8,5
BSTA.550.69.40.L1	69	4000	10360	>70	220 - 240 / 50 - 60	8,5
BSTA.550.69.40.L2	69	4000	10680	>70	220 - 240 / 50 - 60	8,5
BSTA.550.69.40.L3	69	4000	10580	>70	220 - 240 / 50 - 60	8,5
BSTA.550.69.40.L4	69	4000	10460	>70	220 - 240 / 50 - 60	8,5
BSTA. 550.105.40.L1	105	4000	15970	>70	220 - 240 / 50 - 60	8,5
BSTA. 550.105.40.L2	105	4000	15980	>70	220 - 240 / 50 - 60	8,5
BSTA. 550.105.40.L3	105	4000	16010	>70	220 - 240 / 50 - 60	8,5
BSTA. 550.105.40.L4	105	4000	15960	>70	220 - 240 / 50 - 60	8,5
BSTA. 550.140.40.L1	140	4000	19730	>70	220 - 240 / 50 - 60	9
BSTA. 550.140.40.L2	140	4000	19560	>70	220 - 240 / 50 - 60	9

Type Code	Power (w)	CCT (K)	Light Output (lm)	CRI	V/Hz	Weight (Kg)
BSTA. 550.140.40.L3	140	4000	19750	>70	220 - 240 / 50 - 60	9
BSTA. 550.140.40.L4	140	4000	19440	>70	220 - 240 / 50 - 60	9

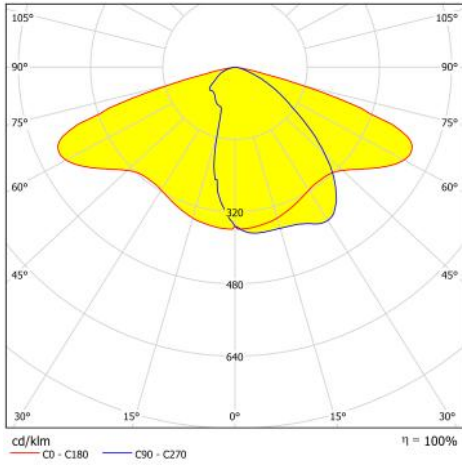

BSTA.550.140.40.L1

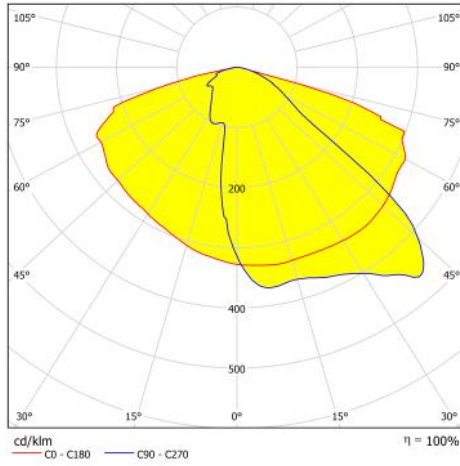

BSTA.550.140.40.L2

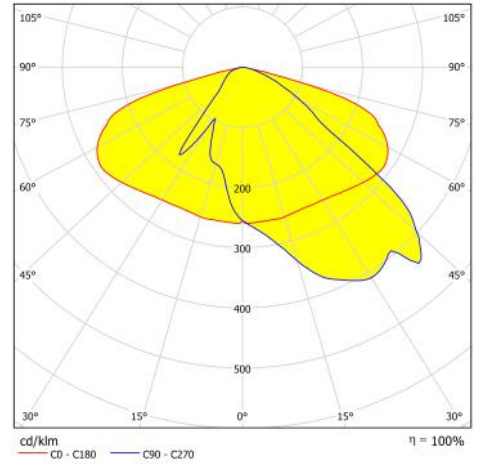

BSTA.550.140.40.L3

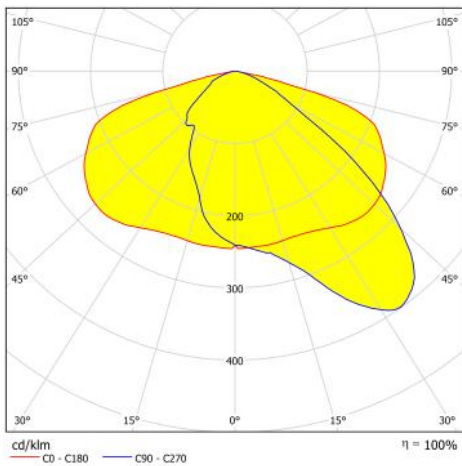

BSTA.550.140.40.L4

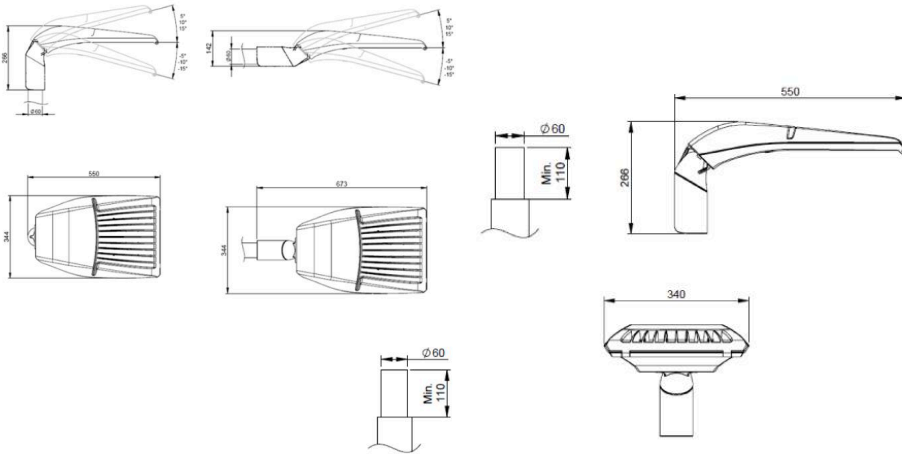



B 3003 BOW



Housing

Aluminum body with electrostatic powder coating.

Pole Ø76mm galvanized, anti-corrosion polyester powder painted steel pole

Glass Tempered, frosted glass.

Led High-efficacy LED MODULE with CRI>80, achieving L90B50 ≥ 50,000 hours of lifetime.

Driver Constant current output LED driver with high efficiency and Pf≥0.95.

Ambient Temperature

-20 °C/+40 °C



Ral 9016 Ral 9005 Ral 9006 ARL-G90

Type Code	Power (w)	CCT (K)	Light Output (lm)	CRI	V/Hz	Weight (Kg)
BBOW.3003.87.30	87	3000	9060	>80	220 - 240 / 50 - 60	35
BBOW.3003.87.40	87	4000	9300	>80	220 - 240 / 50 - 60	35
BBOW.3003.138.30	138	3000	15240	>80	220 - 240 / 50 - 60	35
BBOW.3003.138.40	138	4000	15560	>80	220 - 240 / 50 - 60	35

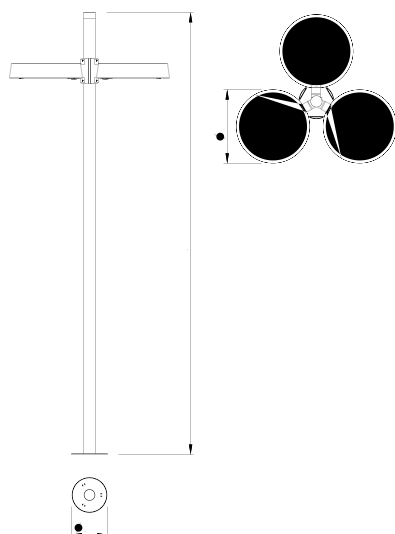



B 3001 BOW



Housing

Aluminum body with electrostatic powder coating.

Pole Ø76mm galvanized, anti-corrosion polyester powder painted steel pole

Glass Tempered, frosted glass.

Led High-efficacy LED MODULE with CRI>80, achieving L90B50 ≥ 50,000 hours of lifetime.

Driver Constant current output LED driver with high efficiency and Pf≥0.95.

Ambient Temperature

-20 °C/+40 °C

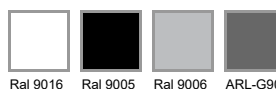

Type Code	Power (w)	CCT (K)	Light Output (lm)	CRI	V/Hz	Weight (Kg)
BBOW.3001.29.30	29	3000	3020	>80	220 - 240 / 50 - 60	2,5
BBOW.3001.29.40	29	4000	3100	>80	220 - 240 / 50 - 60	2,5
BBOW.3001.46.30	46	3000	5080	>80	220 - 240 / 50 - 60	2,5
BBOW.3001.46.40	46	4000	5220	>80	220 - 240 / 50 - 60	2,5

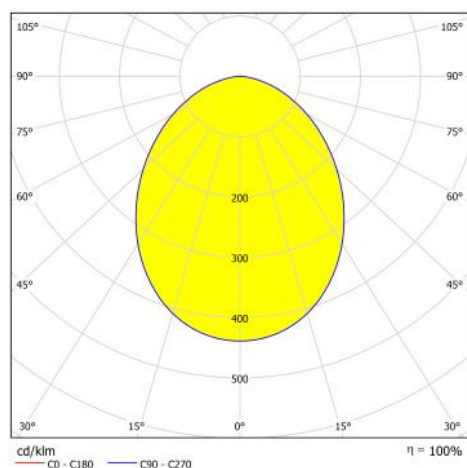

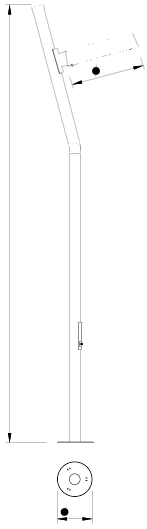

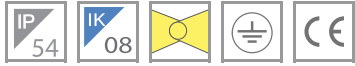

B 2800 SIL



Housing

Ø 150mm diameter, chromate coating for corrosion resistance + electrostatic powder coated aluminum pipe after priming.

Optics

Opal acrylic diffuser

Led

High efficacy PAR38 LED lamp with integrated driver and heatsink. Connected directly to the mains. Achieves 35,000 hours of lifetime and CRI > 80.

Ambient Temperature

-20 °C/+40 °C

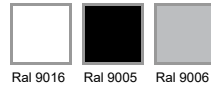

Type Code	Power (w)	CCT (K)	Light Output (lm)	CRI	V/Hz	Weight (Kg)
BSIL.2800.20.27	20	2700	700	>80	220 - 240 / 50 - 60	13

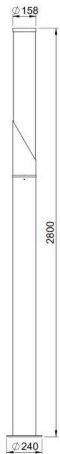

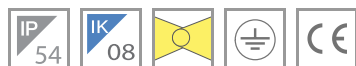

B 1000 SIL



Housing

Ø 150mm diameter, chromate coating for corrosion resistance + electrostatic powder coated aluminum pipe after priming.

Led

High efficacy PAR30 LED lamp with integrated driver and heatsink. Connected directly to the mains. Achieves 40,000 hours of lifetime and CRI > 80.

Optics

Opal tempered glass.

Lamp Base

Porcelain E-27

Ambient Temperature

-20 °C/+40 °C



Type Code	Power (w)	CCT (K)	Light Output (lm)	CRI	V/Hz	Weight (Kg)
BSIL.1000.13.27	13	2700	250	>80	220 - 240 / 50 - 60	7

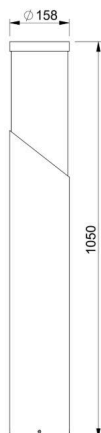



B 0315 HDC



Housing

Ø150mm galvanized, anti-corrosion electrostatic powder painted steel body.

Led

High efficacy PAR30 LED lamp with integrated driver and heatsink. Connected directly to the mains. Achieves 40,000 hours of lifetime and CRI > 80.

Optics

Opal tempered glass.

Lamp Base

Porcelain E-27

Ambient Temperature
-20 °C/+40 °C



Type Code	Power (w)	CCT (K)	Light Output (lm)	CRI	V/Hz	Weight (Kg)
BHDC.315.13.27	25	2700	1300	>80	220 - 240 / 50 - 60	2

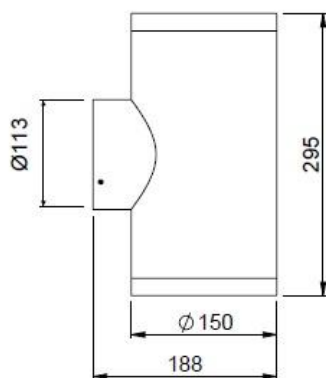



B 0450 SLS

Solis series is designed as a strong product family with its aesthetic look, slim body structure and stylish form. SOLIS-Large which is the member of this product family has a wide optical lens option to be used in many different areas. For fast assembly, it provides external mounting parts to provide precise installation at 5° angles. There are three different lumen alternatives that can be used in different architectural applications. In order to meet special demands, Solis Large can be produced at intermediate levels as well. With external IP68 connector, easy and safe connection can be done without interfering with the product.

Product

Type	B 0450 SLS
Category	Floodlight
Color	Black (RAL 9005)

Technical Data

Light source	High Power LED
Power	152W - 250W
Color temperature	4000K (optional 3000K, 6500K)
Color rendering index	CRI>70 (optional >80)
Beam angle	15°, 25°, 70°, 100°, 20°+115°, ASM-L4, ASM-L8
Luminaire class	Sinif 1
Voltage	220V/240V
Frequency	50/60 Hz
Dimming	Optional (DALI)
Surge protection	Min. 6kV com. mode (L-N-GND)
Luminous flux tolerance	±7%
Power consumption tolerance	±7%
LED life	L90B50 > 130.000 h

Other Information

Ingress protection	IP66
Impact protection	IK08
Weight	11 kg
Dimensions (G x Y x U)	400mm x 450mm x 134mm
Optical cover	Tempered glass
Cable	30 cm with cable connector
Housing Material	Aluminum die cast
Optic material	PMMA
Ambient temperature range	-40...+40 °C (250W) -40...+45 °C (215W) -40...+50 °C (152W)
Performance ambient temp.	25 °C

Type Code	Power (w)	CCT (K)	Light Output (lm)	CRI	V/Hz	Beam Angle	lm/W
BSLS. 0450.245.40.15	245	4000	33830	70	220 - 240 / 50 - 60	15°	138
BSLS. 0450.245.40.25	245	4000	33500	70	220 - 240 / 50 - 60	25°	136
BSLS. 0450.245.40.70	245	4000	32900	70	220 - 240 / 50 - 60	70°	134
BSLS. 0450.245.40.100	245	4000	32220	70	220 - 240 / 50 - 60	100°	132
BSLS. 0450.245.40.20115	245	4000	32420	70	220 - 240 / 50 - 60	20°+115°	133
BSLS. 0450.245.40.ASL4	245	4000	32580	70	220 - 240 / 50 - 60	ASM-L4	133
BSLS. 0450.245.40.ASL8	245	4000	30100	70	220 - 240 / 50 - 60	ASM-L8	123
BSLS. 0450.210.40.15	210	4000	30560	70	220 - 240 / 50 - 60	15°	145
BSLS. 0450.210.40.25	210	4000	29890	70	220 - 240 / 50 - 60	25°	142
BSLS. 0450.210.40.70	215	4000	27470	70	220 - 240 / 50 - 60	70°	131
BSLS. 0450.210.40.100	210	4000	28950	70	220 - 240 / 50 - 60	100°	138
BSLS. 0450.210.40.20115	210	4000	29010	70	220 - 240 / 50 - 60	20°+115°	138
BSLS. 0450.210.40.ASL4	210	4000	29300	70	220 - 240 / 50 - 60	ASM-L4	140
BSLS. 0450.210.40.ASL8	210	4000	29600	70	220 - 240 / 50 - 60	ASM-L8	141
BSLS. 0450.152.40.15	152	4000	24950	70	220 - 240 / 50 - 60	15°	163
BSLS. 0450.152.40.25	152	4000	25300	70	220 - 240 / 50 - 60	25°	166
BSLS. 0450.152.40.70	152	4000	24300	70	220 - 240 / 50 - 60	70°	159
BSLS. 0450.152.40.100	152	4000	24360	70	220 - 240 / 50 - 60	100°	160
BSLS. 0450.152.40.20115	152	4000	23850	70	220 - 240 / 50 - 60	20°+115°	152
BSLS. 0450.152.40.ASL4	152	4000	24850	70	220 - 240 / 50 - 60	ASM-L4	163
BSLS. 0450.152.40.ASL8	152	4000	25250	70	220 - 240 / 50 - 60	ASM-L8	166
BSLS.S. 0450.250.57.15	250	5700	31940	80	220 - 240 / 50 - 60	15°	127
BSLS.S. 0450.250.57.25	250	5700	31440	80	220 - 240 / 50 - 60	25°	125
BSLS.S. 0450.250.57.70	250	5700	30900	80	220 - 240 / 50 - 60	70°	123

Type Code	Power (w)	CCT (K)	Light Output (lm)	CRI	V/Hz	Beam Angle	lm/W
BSLS.S. 0450.250.57.100	250	5700	25960	80	220 - 240 / 50 - 60	100°	125
BSLS.S. 0450.250.57.20115	250	5700	30570	80	220 - 240 / 50 - 60	20°+115°	122
BSLS.S. 0450.250.57.ASL4	250	5700	30050	80	220 - 240 / 50 - 60	ASM-L4	120
BSLS.S. 0450.250.57.ASL8	250	5700	30760	80	220 - 240 / 50 - 60	ASM-L8	122
BSLS.S. 0450.215.57.15	215	5700	28400	80	220 - 240 / 50 - 60	15°	132
BSLS.S. 0450.215.57.25	215	5700	28000	80	220 - 240 / 50 - 60	25°	130
BSLS.S. 0450.215.57.70	215	5700	27470	80	220 - 240 / 50 - 60	70°	128
BSLS.S. 0450.215.57.100	215	5700	26880	80	220 - 240 / 50 - 60	100°	125
BSLS.S. 0450.215.57.20115	215	5700	27710	80	220 - 240 / 50 - 60	20°+115°	129
BSLS.S. 0450.215.57.ASL4	215	5700	26410	80	220 - 240 / 50 - 60	ASM-L4	123
BSLS.S. 0450.215.57.ASL8	215	5700	27350	80	220 - 240 / 50 - 60	ASM-L8	127
BSLS.S. 0450.152.57.15	152	5700	21560	80	220 - 240 / 50 - 60	15°	143
BSLS.S. 0450.152.57.25	152	5700	21270	80	220 - 240 / 50 - 60	25°	141
BSLS.S. 0450.152.57.70	152	5700	20970	80	220 - 240 / 50 - 60	70°	139
BSLS.S. 0450.152.57.100	152	5700	19900	80	220 - 240 / 50 - 60	100°	132
BSLS.S. 0450.152.57.20115	152	5700	20840	80	220 - 240 / 50 - 60	20°+115°	138
BSLS.S. 0450.152.57.ASL4	152	5700	20020	80	220 - 240 / 50 - 60	ASM-L4	133
BSLS.S. 0450.152.57.ASL8	152	5700	20670	80	220 - 240 / 50 - 60	ASM-L8	137

15°

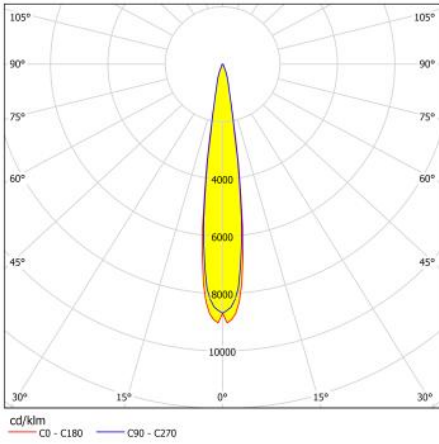

BSLS.0450.250.40.15

25°

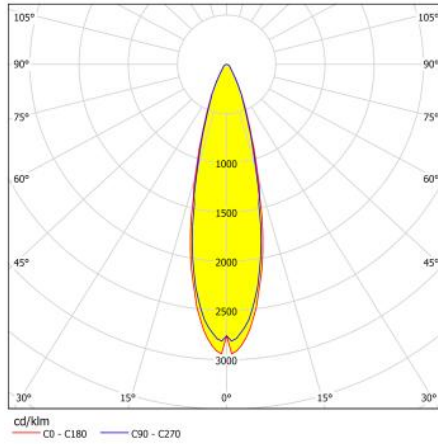

BSLS.0450.250.40.25

70°

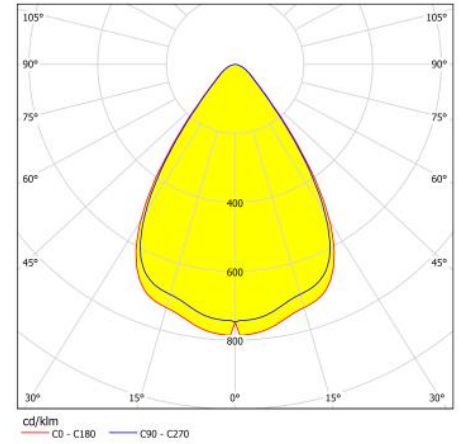

BSLS.0450.250.40.70

100°

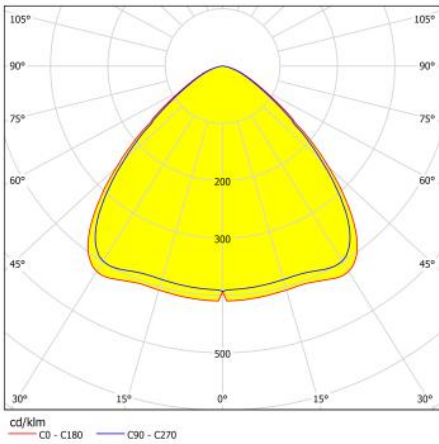

BSLS.0450.250.40.100

20°+115°

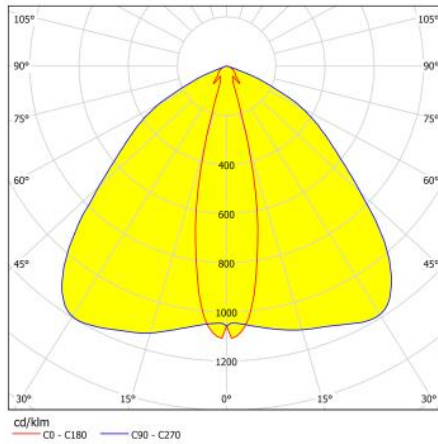

BSLS.0450.250.40.20115

ASM-L4

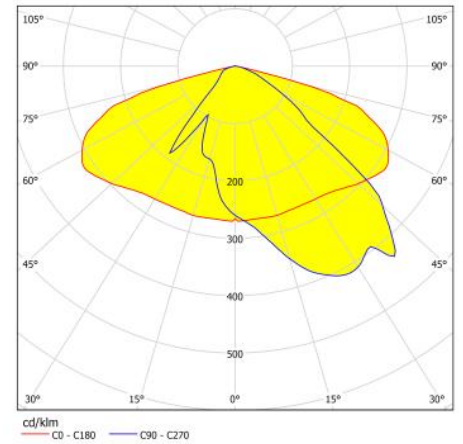

BSLS.0450.250.40.ASL4

ASM-L8

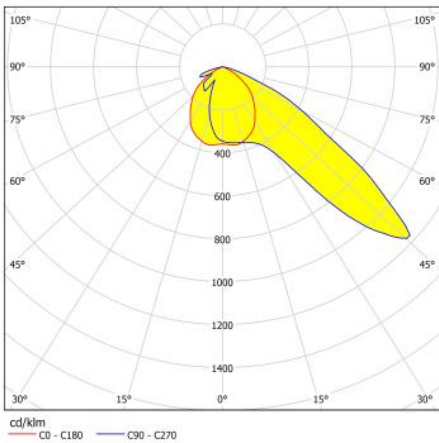

BSLS.0450.250.40.ASL8

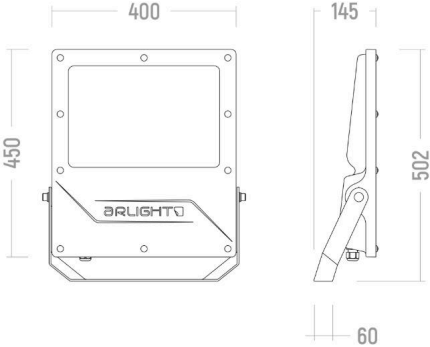



B 0375 SLS

Solis series is designed as a strong product family with its aesthetic look, slim body structure and stylish form. SOLIS-Medium which is the member of this product family has a wide optical lens option to be used in many different areas. For fast assembly, it provides external mounting parts to provide precise installation at 5° angles. There are three different lumen alternatives that can be used in different architectural applications. In order to meet special demands, Solis Medium can be produced at bigger levels as well. With external IP68 connector, easy and safe connection can be done without interfering with the product.

Product

Type	B 0375 SLS
Category	Floodlight
Color	Black (RAL 9005)

Technical Data

Light source	High Power LED
Power	48W - 140W
Color temperature	4000K (optional 3000K, 6500K)
Color rendering index	CRI>70 (optional >80)
Beam angle	15°, 25°, 70°, 100°, 20°+115°, ASM-L4, ASM-L8
Luminaire class	Sınıf 1
Voltage	220V/240V
Frequency	50/60 Hz
Dimming	Optional (DALI)
Surge protection	Min. 6kV com. mode (L-N-GND)
Luminous flux tolerance	±7%
Power consumption tolerance	±7%
LED life	L90B50 > 130.000 h

Other Information

Ingress protection	IP66
Impact protection	IK08
Weight	7 kg
Dimensions (G x Y x U)	300mm x 375mm x 123mm
Optical cover	Tempered glass
Cable	30 cm with cable connector
Housing Material	Aluminum die cast
Optic material	PMMA
Ambient temperature range	-40...+40 °C (135W) -40...+50 °C (48W, 69W, 105W)
Performance ambient temp.	25 °C

Type Code	Power (w)	CCT (K)	Light Output (lm)	CRI	V/Hz	Beam Angle	lm/W
BSLS. 0375.140.40.15	140	4000	18930	70	220 - 240 / 50 - 60	15°	135
BSLS. 0375.140.40.25	140	4000	18500	70	220 - 240 / 50 - 60	25°	132
BSLS. 0375.140.40.70	140	4000	19020	70	220 - 240 / 50 - 60	70°	135
BSLS. 0375.140.40.100	140	4000	17300	70	220 - 240 / 50 - 60	100°	123
BSLS. 0375.140.40.20115	140	4000	18400	70	220 - 240 / 50 - 60	20°+115°	131
BSLS. 0375.140.40.ASL4	140	4000	18060	70	220 - 240 / 50 - 60	ASM-L4	129
BSLS. 0375.140.40.ASL8	140	4000	18700	70	220 - 240 / 50 - 60	ASM-L8	133
BSLS. 0375.105.40.15	105	4000	15590	70	220 - 240 / 50 - 60	15°	148
BSLS. 0375.105.40.25	105	4000	15420	70	220 - 240 / 50 - 60	25°	146
BSLS. 0375.105.40.70	105	4000	15550	70	220 - 240 / 50 - 60	70°	139
BSLS. 0375.105.40.100	105	4000	14640	70	220 - 240 / 50 - 60	100°	139
BSLS. 0375.105.40.20115	105	4000	15110	70	220 - 240 / 50 - 60	20°+115°	143
BSLS. 0375.105.40.ASL4	105	4000	14905	70	220 - 240 / 50 - 60	ASM-L4	141
BSLS. 0375.105.40.ASL8	105	4000	15320	70	220 - 240 / 50 - 60	ASM-L8	145
BSLS. 0375.69.40.15	69	4000	10930	70	220 - 240 / 50 - 60	15°	158
BSLS. 0375.69.40.25	69	4000	10700	70	220 - 240 / 50 - 60	25°	155
BSLS. 0375.69.40.70	69	4000	10850	70	220 - 240 / 50 - 60	70°	157
BSLS. 0375.69.40.100	69	4000	10300	70	220 - 240 / 50 - 60	100°	149
BSLS. 0375.69.40.20115	69	4000	10600	70	220 - 240 / 50 - 60	20°+115°	153
BSLS. 0375.69.40.ASL4	69	4000	10350	70	220 - 240 / 50 - 60	ASM-L4	150
BSLS. 0375.69.40.ASL8	69	4000	10600	70	220 - 240 / 50 - 60	ASM-L8	153
BSLS. 0375.48.40.15	48	4000	7990	70	220 - 240 / 50 - 60	15°	166
BSLS. 0375.48.40.25	48	4000	7800	70	220 - 240 / 50 - 60	25°	162
BSLS. 0375.48.40.70	48	4000	7710	70	220 - 240 / 50 - 60	70°	161

Type Code	Power (w)	CCT (K)	Light Output (lm)	CRI	V/Hz	Beam Angle	lm/W
BSLS. 0375.48.40.100	48	4000	7560	70	220 - 240 / 50 - 60	100°	157
BSLS. 0375.48.40.20115	48	4000	7880	70	220 - 240 / 50 - 60	20°+115°	164
BSLS. 0375.48.40.ASL4	48	4000	7630	70	220 - 240 / 50 - 60	ASM-L4	158
BSLS. 0375.48.40.ASL8	48	4000	7930	70	220 - 240 / 50 - 60	ASM-L8	165
BSLS.S. 0375.140.57.15	140	5700	17590	80	220 - 240 / 50 - 60	15°	126
BSLS.S. 0375.140.57.25	140	5700	17190	80	220 - 240 / 50 - 60	25°	123
BSLS.S. 0375.140.57.70	140	5700	17160	80	220 - 240 / 50 - 60	70°	123
BSLS.S. 0375.140.57.100	140	5700	16570	80	220 - 240 / 50 - 60	100°	118
BSLS.S. 0375.140.57.20115	140	5700	16600	80	220 - 240 / 50 - 60	20°+115°	119
BSLS.S. 0375.140.57.ASL4	140	5700	16380	80	220 - 240 / 50 - 60	ASM-L4	117
BSLS.S. 0375.140.57.ASL8	140	5700	16570	80	220 - 240 / 50 - 60	ASM-L8	122
BSLS.S. 0375.105.57.15	105	5700	14250	80	220 - 240 / 50 - 60	15°	136
BSLS.S. 0375.105.57.25	105	5700	14025	80	220 - 240 / 50 - 60	25°	134
BSLS.S. 0375.105.57.70	105	5700	13920	80	220 - 240 / 50 - 60	70°	133
BSLS.S. 0375.105.57.100	105	5700	13430	80	220 - 240 / 50 - 60	100°	128
BSLS.S. 0375.105.57.20115	105	5700	13585	80	220 - 240 / 50 - 60	20°+115°	130
BSLS.S. 0375.105.57.ASL4	105	5700	13100	80	220 - 240 / 50 - 60	ASM-L4	125
BSLS.S. 0375.105.57.ASL8	105	5700	13580	80	220 - 240 / 50 - 60	ASM-L8	129
BSLS.S. 0375.69.57.15	69	5700	9790	80	220 - 240 / 50 - 60	15°	144
BSLS.S. 0375.69.57.25	69	5700	9650	80	220 - 240 / 50 - 60	25°	142
BSLS.S. 0375.69.57.70	69	5700	9580	80	220 - 240 / 50 - 60	70°	141
BSLS.S. 0375.69.57.100	69	5700	9245	80	220 - 240 / 50 - 60	100°	136
BSLS.S. 0375.69.57.20115	69	5700	9380	80	220 - 240 / 50 - 60	20°+115°	138
BSLS.S. 0375.69.57.ASL4	69	5700	9110	80	220 - 240 / 50 - 60	ASM-L4	134

Type Code	Power (w)	CCT (K)	Light Output (lm)	CRI	V/Hz	Beam Angle	lm/W
BSLS.S. 0375.69.57.ASL8	69	5700	9315	80	220 - 240 / 50 - 60	ASM-L8	137
BSLS.S. 0375.48.57.15	48	5700	7240	80	220 - 240 / 50 - 60	15°	150
BSLS.S. 0375.48.57.25	48	5700	7110	80	220 - 240 / 50 - 60	25°	147
BSLS.S. 0375.48.57.70	48	5700	7020	80	220 - 240 / 50 - 60	70°	145
BSLS.S. 0375.48.57.100	48	5700	6765	80	220 - 240 / 50 - 60	100°	140
BSLS.S. 0375.48.57.20115	48	5700	6890	80	220 - 240 / 50 - 60	20°+115°	142
BSLS.S. 0375.48.57.ASL4	48	5700	6700	80	220 - 240 / 50 - 60	ASM-L4	139
BSLS.S. 0375.48.57.ASL8	48	5700	6895	80	220 - 240 / 50 - 60	ASM-L8	143

15°

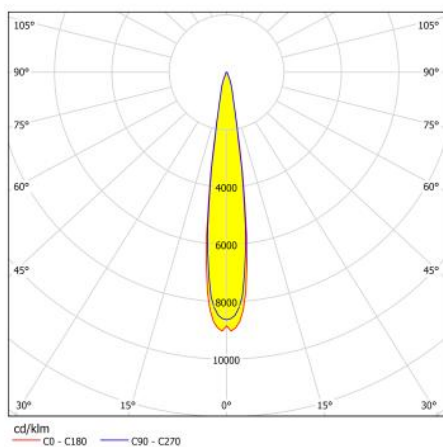

BSLS.0375.135.40.15

25°

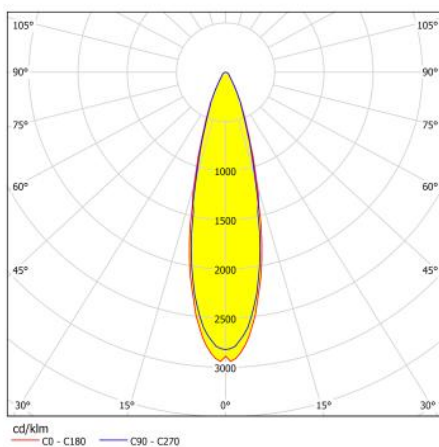

BSLS.0375.135.40.25

70°

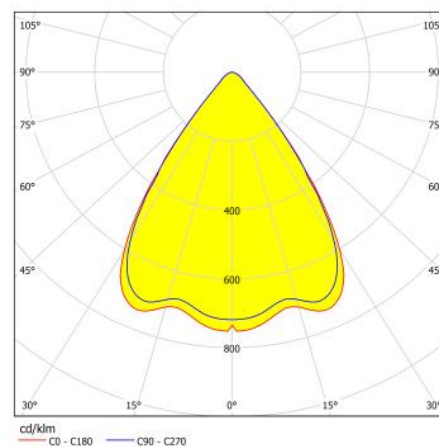

BSLS.0375.135.40.70

100°

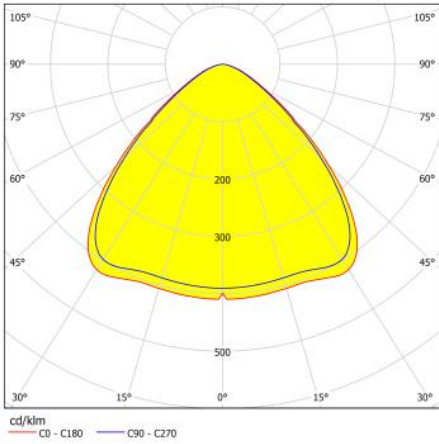

BSLS.0375.135.40.100

20°+115°

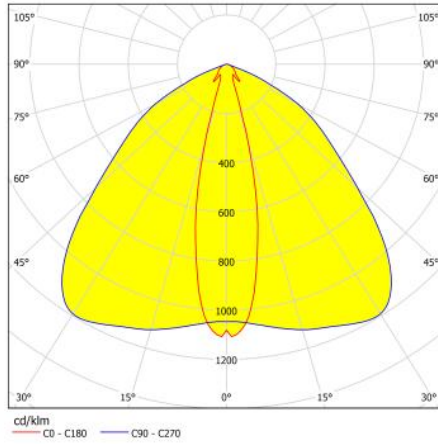

BSLS.0375.135.40.20115

ASM-L4

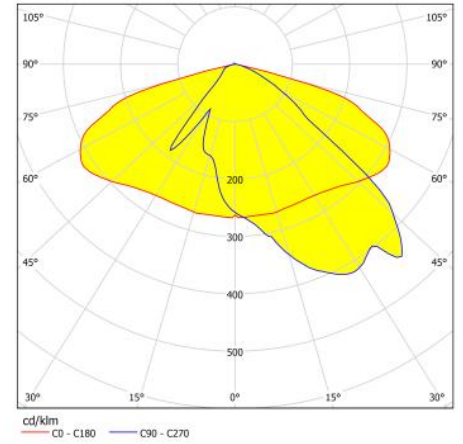

BSLS.0375.135.40.ASL4

ASM-L8

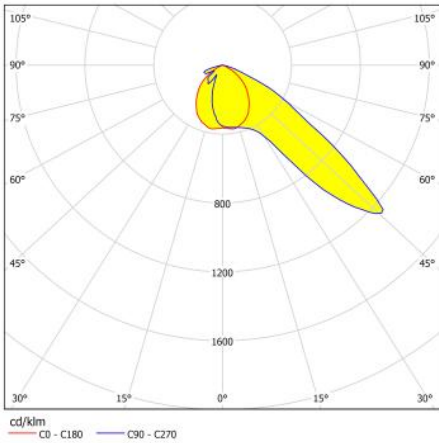

BSLS.0375.135.40.ASL8

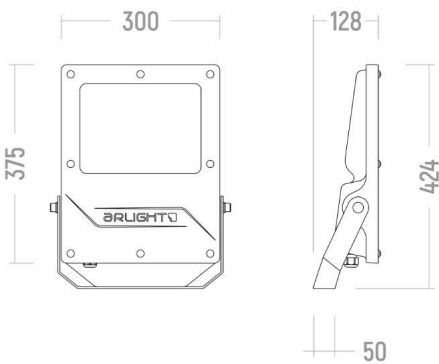



B 0140 STN-G



Housing

Anti-corrosion electrostatic powder painted aluminium body

Led

PAR16 LED lamp

Optics

Transparent tempered glass

Lamp Base

GU 10

Ambient Temperature

-20 °C/+40 °C



Ral 9016 Ral 9005 Ral 9006

Type Code	Power (w)	CCT (K)	Light Output (lm)	CRI	V/Hz	Weight (Kg)	Lamp Base
BSTN-G.140.5.40	5	4000	450	>80	220 - 240 / 50 - 60	1,0	GU 10

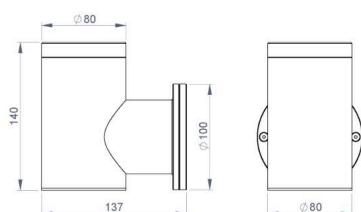



B 0250 STN



Housing

Anti-corrosion electrostatic powder painted aluminium body

Led

High-efficacy High Power LED with CRI>80, achieving L70B50 ≥ 50,000 hours of lifetime.

Optics

Highly efficient PMMA lens, designed specially for High Power LED.

Diffuser

Transparent tempered glass

Ambient Temperature

-20 °C/+40 °C

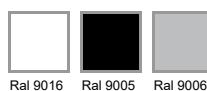

Type Code	Power (w)	CCT (K)	Light Output (lm)	CRI	V/Hz	Weight (Kg)	Beam Angle
BSTN.250.60.11.30	11	3000	965	>80	220 - 240 / 50 - 60	1,5	60°
BSTN.250.60.11.40	11	4000	1045	>80	220 - 240 / 50 - 60	1,5	60°
BSTN.250.35.11.30	11	3000	1020	>80	220 - 240 / 50 - 60	1,5	35°
BSTN.250.35.11.40	11	4000	1100	>80	220 - 240 / 50 - 60	1,5	35°
BSTN.250.25.11.30	11	3000	1050	>80	220 - 240 / 50 - 60	1,5	25°
BSTN.250.25.11.40	11	4000	1135	>80	220 - 240 / 50 - 60	1,5	25°

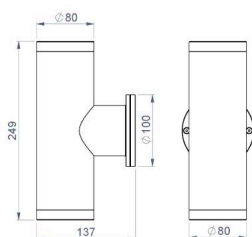



B 0250 STN-G



Housing

Anti-corrosion electrostatic powder painted aluminium body

Led

PAR16 LED lamp

Optics

Transparent tempered glass

Lamp Base

GU 10

Ambient Temperature

-20 °C/+40 °C

NOTE

This product is supplied without a bulb as standard. The lighting status and performance shown are representative and may vary depending on the bulb model to be used. We are the standard for our company for bulb options.



Type Code	Power (w)	CCT (K)	Light Output (lm)	CRI	V/Hz	Weight (Kg)	Lamp / Led	Lamp Base
BSTN-G.250.10.40	10	4000	850	>80	220 - 240 / 50 - 60	1,5	PAR16 Led	GU 10

